

User's Guide

**EXTECH**<sup>®</sup>  
**INSTRUMENTS**

A FLIR COMPANY

# 400Amp True RMS AC/DC Clamp Meter with IR Thermometer

Model EX623

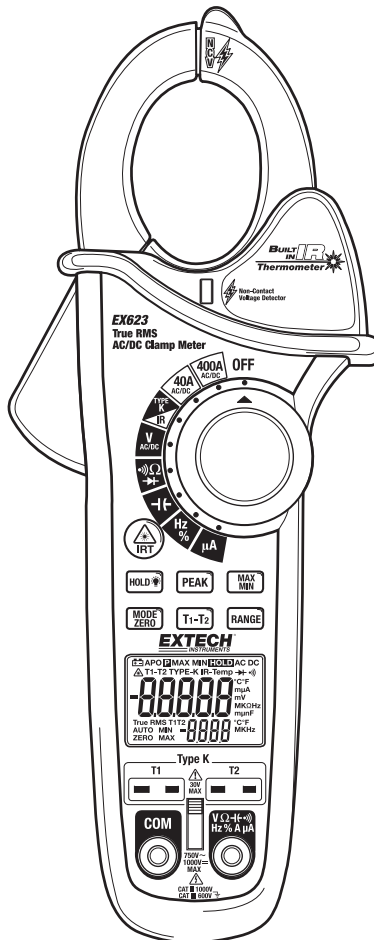

# Introduction

---

Congratulations on your purchase of this Extech EX623 True RMS Clamp Meter. This meter measures AC Current, DC Current, AC/DC Voltage, Resistance, Capacitance, Frequency, Diode Test, Duty Cycle and Continuity. Special features include Dual Input Thermocouple Temperature, Non-Contact IR Temperature and Non-Contact Voltage detector. The double molded case is designed for heavy duty use. This meter is shipped fully tested and calibrated and, with proper use, will provide years of reliable service.

## Safety

---

### International Safety Symbols



This symbol, adjacent to another symbol or terminal, indicates the user must refer to the manual for further information.



This symbol, adjacent to a terminal, indicates that, under normal use, hazardous voltages may be present



Double insulation



This **WARNING** symbol indicates a potentially hazardous situation, which if not avoided, could result in death or serious injury.



This **CAUTION** symbol indicates a potentially hazardous situation, which if not avoided, may result damage to the product.

### PER IEC1010 OVERVOLTAGE INSTALLATION CATEGORY

#### OVERVOLTAGE CATEGORY I

Equipment of OVERVOLTAGE CATEGORY I is equipment for connection to circuits in which measures are taken to limit the transient overvoltages to an appropriate low level.

Note – Examples include protected electronic circuits.

#### OVERVOLTAGE CATEGORY II

Equipment of OVERVOLTAGE CATEGORY II is energy-consuming equipment to be supplied from the fixed installation.

Note – Examples include household, office, and laboratory appliances.

#### OVERVOLTAGE CATEGORY III

Equipment of OVERVOLTAGE CATEGORY III is equipment in fixed installations.

Note – Examples include switches in the fixed installation and some equipment for industrial use with permanent connection to the fixed installation.

#### OVERVOLTAGE CATEGORY IV

Equipment of OVERVOLTAGE CATEGORY IV is for use at the origin of the installation.

Note – Examples include electricity meters and primary over-current protection equipment

## SAFETY NOTES

- Do not exceed the maximum allowable input range of any function.
- Do not apply voltage to meter when resistance function is selected.
- Set the function switch OFF when the meter is not in use.
- Remove the battery if meter is to be stored for longer than 60 days.

## WARNINGS

- Set function switch to the appropriate position before measuring.
- When measuring volts do not switch to current/resistance modes.
- Do not measure current on a circuit whose voltage exceeds 600V.
- When changing ranges always disconnect the test leads from the circuit under test.

## CAUTIONS

- Improper use of this meter can cause damage, shock, injury or death. Read and understand this user manual before operating the meter.
- Always remove the test leads before replacing the battery or fuses.
- Inspect the condition of the test leads and the meter itself for any damage before operating the meter. Repair or replace any damage before use.
- Use great care when making measurements if the voltages are greater than 25VAC rms or 35VDC. These voltages are considered a shock hazard.
- Always discharge capacitors and remove power from the device under test before performing Diode, Resistance or Continuity tests.
- Voltage checks on electrical outlets can be difficult and misleading because of the uncertainty of connection to the recessed electrical contacts. Other means should be used to ensure that the terminals are not "live".
- If the equipment is used in a manner not specified by the manufacturer, the protection provided by the equipment may be impaired.
- This device is not a toy and must not reach children's hands. It contains hazardous objects as well as small parts that the children could swallow. In case a child swallows any of them, please contact a physician immediately
- Do not leave batteries and packing material lying around unattended; they can be dangerous for children if they use them as toys
- In case the device is going to be unused for an extended period of time, remove the batteries to prevent them from draining
- Expired or damaged batteries can cause cauterization on contact with the skin. Always, therefore, use suitable hand gloves in such cases
- See that the batteries are not short-circuited. Do not throw batteries into the fire.
- **Do not directly view or direct the laser pointer at an eye.** Low power visible lasers do not normally present a hazard, but may present some potential for hazard if viewed directly for extended periods of time

Function	Maximum Input
A AC,	400A DC/AC
A DC	400A DC/AC
V DC, V AC	600V DC/AC
Resistance, Capacitance, Frequency, Diode Test	250V DC/AC
$\mu$ A	4000 $\mu$ A
Type K Temperature	30V DC, 24V AC

# Description

## Meter Description

1. Current clamp
2. Clamp opening trigger
3. IR thermometer and Laser Button
4. HOLD/BACKLIGHT button
5. MODE / ZERO button
6. Backlit LCD Display
7. Type K input jacks
8. Multimeter input jacks
9. IR thermometer sensor and Laser pointer (rear)
10. Function switch
11. PEAK button
12. MAX/MIN button
13. Range button
14. Thermocouple display button
15. Battery compartment (rear)
16. Non-Contact Voltage Detector
17. NCV LED indicator
18. Input shutter

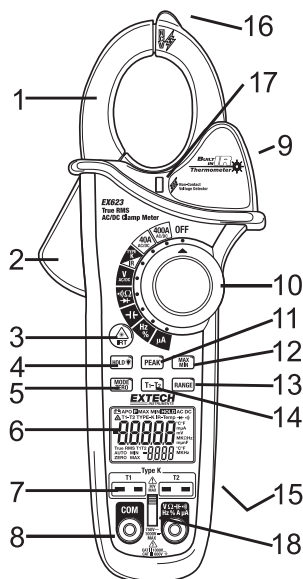

## Display icons Description

HOLD	Data Hold
APO	Auto Power Off
AUTO	Autoranging
	Peak Hold
DC	Direct Current
AC	Alternating Current
MAX	Max reading
MIN	Min reading
	Low battery
ZERO	DCA or CAP zero
mV or V	Milli-volts or Volts (Voltage)
$\Omega$	Ohms (Resistance)
A	Amperes (Current)
F	Farad (Capacitance)
Hz	Hertz (Frequency)
%	Duty Ratio
$^{\circ}$ F and $^{\circ}$ C	Fahrenheit and Celsius units (Temperature)
T1, T2, T1-T2	Thermocouple 1, Thermocouple 2, Thermocouple difference
n, m, $\mu$ , M, k	Unit of measure prefixes: nano, milli, micro, mega, and kilo
	Continuity test
	Diode test
	Laser pointer

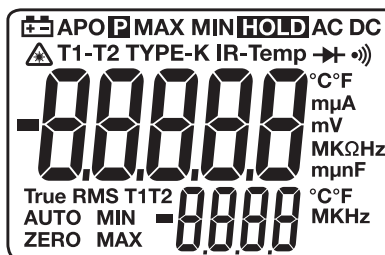

## Operation

**NOTES:** Read and understand all **Warning** and **Caution** statements in this operation manual prior to using this meter. Set the function select switch to the OFF position when the meter is not in use.

### Input Shutter

The Input Shutter inhibits simultaneous connection to the thermocouple jacks and the DMM input jacks. This is a safety feature which prevents a potentially hazardous condition from existing during high voltage measurements. Slide the shutter up for test lead measurements or slide it down for thermocouple temperature measurements.

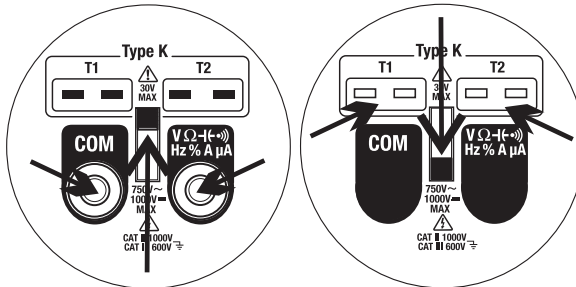

### Non-Contact Voltage Detector

**WARNING:** Risk of Electrocution. Before use, always test the Voltage Detector on a known live circuit to verify proper operation.

1. Rotate the Function switch to any measurement position.
2. Place the detector probe tip on the conductor to be tested.
3. If AC voltage is present, the NCV detector light will turn on with a steady red light.

**NOTE:** The conductors in electrical cord sets are often twisted. For best results, move the probe tip along a length of the cord to assure placing the tip in close proximity to the live conductor.

**NOTE:** The detector is designed with high sensitivity. Static electricity or other sources of energy may randomly trip the sensor. This is normal operation.

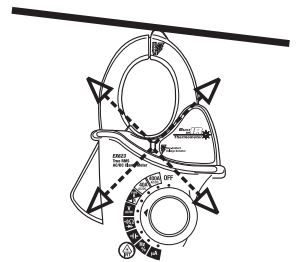

## AC/DC Current Measurements

**WARNING:** Disconnect the test leads before making clamp measurements.

1. Rotate the Function switch to the **400Aac/dc** position
2. Press the **MODE** button to select AC or DC.
3. Press the trigger to open jaw. Fully enclose only one conductor.
4. Read the current value in the display.
5. If the value is less than 40A, rotate the function switch to the **40Aac/dc** position to improve resolution.

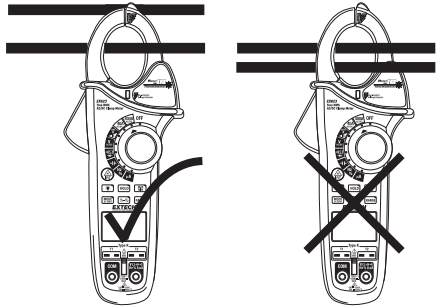

### DCA Zero

The Zero feature removes offset values and improves accuracy for DC current measurements. To perform a zero, select ADC and, with no conductor in the jaw, press and hold the MODE ZERO button for two beeps. The display will zero. The offset value is now stored and removed from all measurements.

### Frequency

When ACV is selected, the measured frequency can be viewed in the lower display.

## AC/DC Voltage Measurements

**CAUTION:** Do not measure voltages if a motor on the circuit is being switched ON or OFF. Large voltage surges may occur that can damage the meter.

1. Slide the input shutter to the up position.
2. Rotate the function switch to the **V** position.
3. Press the **MODE** button to select AC or DC Voltage.
4. Insert the black test lead banana plug into the negative **COM** jack. Insert the red test lead banana plug into the positive **V** jack.
5. Touch the black test probe tip to the negative side of the circuit. Touch the red test probe tip to the positive side of the circuit.
6. Read the voltage value in the display.

### Frequency

When ACA is selected, the measured frequency can be viewed in the lower display.



## Resistance Measurements

Note: Remove power from the device under test before making resistance measurements

1. Slide the input shutter to the up position.
2. Set the function switch to the  $\Omega$  position.
3. Insert the black test lead banana plug into the negative **COM** jack. Insert the red test lead banana plug into the positive **V** jack.
4. Touch the black test probe tip to one side of the device. Touch the red test probe tip to the other side of the device.
5. Read the resistance value in the display.

## Continuity Test

1. Connect as described for resistance measurements.
2. Press the **MODE** button to select continuity (•)).
3. Touch the test probe tips across the circuit or component under test.
4. If the resistance is  $< 50\Omega$ , a tone will sound.

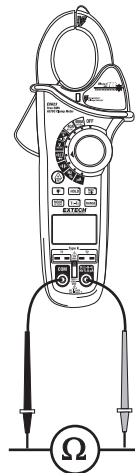

## Diode Test

1. Connect as described for resistance measurements
2. Press the **MODE** button to select diode test  $\rightarrow|$ .
3. Touch the test probe tips to the diode or semiconductor junction under test. Note the meter reading.
4. Reverse the test lead polarity by reversing the red and black leads. Note this reading.
5. The diode or junction can be evaluated as follows:
  - If one reading displays a value (typically 0.400V to 01.800V) and the other reading displays **OL**, the diode is good.
  - If both readings display **OL** the device is open.
  - If both readings are very small or '0', the device is shorted.

## Capacitance Measurements

**WARNING:** To avoid electric shock, discharge the capacitor before measuring.

1. Slide the input shutter to the up position.
2. Rotate the function switch to the  $\text{F}$  capacitance position.
3. Insert the black test lead banana plug into the negative **COM** jack. Insert the red test lead banana plug into the positive  $\text{F}$  jack.
4. Touch the black test probe tip to one side of the device. Touch the red test probe tip to the other side of the device.
5. Read the capacitance value in the display.

Note: For very large values of capacitance measurement time can be several seconds before the final reading stabilizes.

Note: The Zero feature removes stray test lead capacitance to improve the accuracy of low value capacitance measurements. To perform a zero, Press and hold the **MODE ZERO** button for two beeps. The display will zero. The offset value is now stored and is removed from all measurements.

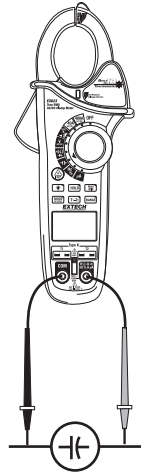

## Frequency and Duty Ratio Measurements

1. Slide the input shutter to the up position.
2. Rotate the function switch to the **Hz %** Position.
3. Insert the black test lead banana plug into the negative **COM** jack. Insert the red test lead banana plug into the positive **Hz** jack.
4. Touch the black test probe tip to one side of the device. Touch the red test probe tip to the other side of the device.
5. Read the Frequency value on the upper large display. Read the Duty Ratio on the lower small display.
6. Press the **MODE** button to display the Duty Ratio on the large display.

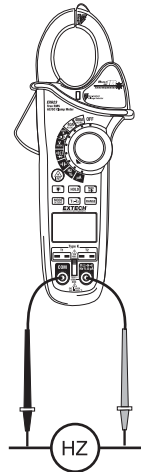



## $\mu\text{A}$ DC/AC Current Measurements

1. Slide the input shutter to the up position.
2. Rotate the function switch to the  $\mu\text{A}$  position.
3. Press the **MODE** button to select AC or DC.
4. Insert the black test lead banana plug into the negative **COM** jack. Insert the red test lead banana plug into the positive  $\mu\text{A}$  jack.
5. Turn power to the circuit under test off and make a break in the circuit.
6. Insert the meter in series with the circuit;  
Touch the black test probe tip to the negative side of the break.  
Touch the red test probe tip to the positive side of the break.
7. Turn circuit power on.
8. Read the current value in the display.

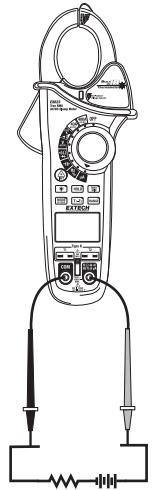

## Type K Temperature Measurements

1. Slide the input shutter to the down position.
2. Rotate the function switch to the **TYPE K** temperature position.
3. Press the MODE button to select °F or °C.
4. Insert the Temperature Probe(s) into the T1 and/or T2 type k sockets.
5. Place the temperature probe tip(s) where needed.
6. Read the temperature on the display.
7. Press the **T1-T2** button to step through the display combinations:

Upper display	Lower display
a. T1	T2
b. T2	T1
c. T1-T2	T1
d. T1- T2	T2

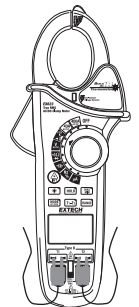

**Note:** In case of an open input or a temperature overrange, the meter will display “- - -”.

## Non-Contact InfraRed Temperature Measurements

1. Rotate the function switch to the **IR** position.
2. Press the **MODE** button to select °F or °C.
3. Aim the infrared sensor (rear of the meter) at the surface to be measured.
4. Press the **IRT**  button to turn on the IR thermometer and laser pointer. The laser pointer identifies the surface spot to be measured.
5. The area of the surface to be measured must be larger than the spot size as determined by the distance to spot size specification.
6. Read the temperature in the large upper display. When the IRT button is released the displayed temperature will be held for approx. 10 seconds.
7. Read the MAX temperature in the lower display. Press the MAX/MIN button to toggle the lower display between the maximum and minimum measured values.

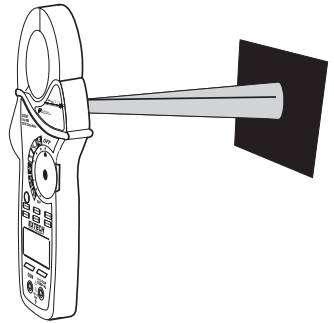

**WARNING: Do not directly view or direct the laser pointer at an eye.**  
 Low power visible lasers do not normally present a hazard, but may present some potential for hazard if viewed directly for extended periods of time.

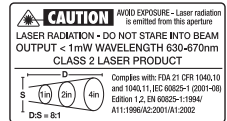

### IR Spot to Distance Diagram

The 8:1 spot to distance ratio determines the size of the measured surface area with respect to the distance the meter is held away from the surface.

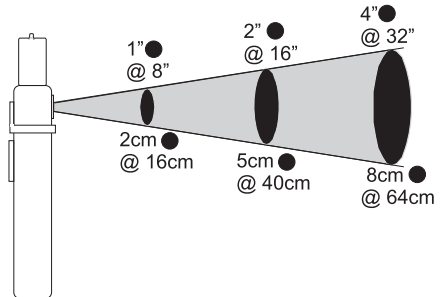

### IR Measurement Notes

1. The object under test should be larger than the spot (target) size calculated by the field of view diagram.
2. If the surface of the object under test is covered with frost, oil, grime, etc., clean before taking measurements.
3. If an object's surface is highly reflective, apply masking tape or flat black paint to the surface before measuring.
4. The meter may not make accurate measurements through transparent surfaces such as glass.
5. Steam, dust, smoke, etc. can obscure measurements.
6. To find a hot spot, aim the meter outside the area of interest then scan across (in an up and down motion) until the hot spot is located.

## Data Hold

To freeze the LCD reading, press the **HOLD** button. While data hold is active, the **HOLD** icon appears on the LCD. Press the **HOLD** button again to return to normal operation.

## MAX/MIN

1. Press the **MAX/MIN** button to activate the MAX/MIN recording mode. The display icon "**MAX**" will appear. The meter will begin recording and displaying the maximum value measured.
2. Press the **MAX/MIN** button and "**MIN**" will appear. The meter will display the minimum value measured during the recording session.
3. Press the **MAX/MIN** button and "**MAX MIN**" will appear. The meter will display the present reading, but will continue to update and store the max and min readings.
4. To exit MAX/MIN mode press and hold the **MAX/MIN** button for 2 seconds.

## Peak Hold

When ACA or ACV is selected, pressing the **PEAK** button enables the peak capture circuit. The meter will now capture and display the maximum and minimum peaks of the waveform.

## RANGE

In the Voltage, Resistance, Capacitance, Frequency or uA function the meter automatically selects the best range for the measurements being made. For measurement situations requiring that a range be manually selected, perform the following:

1. Press the **RANGE** button. The "**AUTO**" display icon will turn off.
2. Press the **RANGE** key to step through the available ranges. Observe the decimal point and units displayed until the preferred range is located.
3. To exit the Manual Ranging mode and return to Autoranging, press and hold the **RANGE** key for 2 seconds.

## LCD Backlight

The LCD is equipped with backlighting for easier viewing, especially in dimly lit areas. Press and hold the **HOLD**/ button for 2 seconds to turn the backlight on. The backlight will automatically turn off after 30 seconds.

## Automatic Power OFF with Disable

In order to conserve battery life, the meter will automatically turn off after approximately 30 minutes. To turn the meter on again, turn the function switch to the OFF position and then to the desired function position.

To disable APO:

1. From the OFF position, hold the MODE button and rotate the FUNCTION switch to a measurement function.
2. *APO d* will appear in the display
3. Release the MODE button
4. APO is now disabled (APO icon is off) and will be reset when the Function switch is returned to the OFF position.

## Low battery indication

When the  icon appears in the display, the battery should be replaced. Refer to the battery replacement procedure in the maintenance section.

## Maintenance

---

**WARNING:** To avoid electrical shock, disconnect the meter from any circuit, remove the test leads from the input terminals, and turn OFF the meter before opening the case. Do not operate the meter with an open case.

### Cleaning and Storage

Periodically wipe the case with a damp cloth and mild detergent; do not use abrasives or solvents. If the meter is not to be used for 60 days or more, remove the battery and store it separately.

### Battery Replacement

1. Remove the Phillips head screw that secures the rear battery door
2. Open the battery compartment
3. Replace the 9V battery
4. Secure the battery compartment door
- 5.



You, as the end user, are legally bound (**EU Battery ordinance**) to return all used batteries, **disposal in the household garbage is prohibited!** You can hand over your used batteries / accumulators at collection points in your community or wherever batteries / accumulators are sold!

**Disposal:** Follow the valid legal stipulations in respect of the disposal of the device at the end of its lifecycle

### Fuse Replacement

1. Remove the battery
2. Remove the Phillips head screws (2) that secure the rear cover.
3. Replace the fuse with one of equal rating. (200mA, 660V ceramic fast blow, 5x20mm [SIBA 70-180-40])
4. Replace the rear cover and battery

## Specifications

Function	Range	Resolution	Accuracy (% of reading + digits)
<b>AC Current</b> 50/60 Hz True RMS	400.0 AAC	0.1A	±(1.5% + 5 digits)
	40.00 AAC	0.01A	
<b>DC Current</b>	400.0 ADC	0.1A	±(1.5% + 5 digits)
	40.00 ADC	0.01A	
<b>AC/DC <math>\mu</math>A Current</b>	400.00 $\mu$ A	0.01 $\mu$ A	DC: ±(1.0% + 2 digits)
	4000.0 $\mu$ A	0.1 $\mu$ A	AC: ±(1.5% + 2 digits)
<b>AC Voltage</b> 50/60 Hz True RMS	400.0 mVAC	0.1mV	±(1.0% + 20 digits)
	4.000 VAC	0.001V	±(2.0% + 5 digits)
	40.00 VAC	0.01V	
	400.0 VAC	0.1V	
	600 VAC	1V	
<b>DC Voltage</b>	400.00 mVDC	0.01mV	±(0.1% + 6 digits)
	4.0000 VDC	0.0001V	
	40.000 VDC	0.001V	
	400.00 VDC	0.01V	
	600.0 VDC	0.1V	±(1.0% + 2 digits)
<b>Resistance</b>	400.00 $\Omega$	0.01 $\Omega$	±(0.8% + 20 digits)
	4.0000k $\Omega$	0.0001k $\Omega$	±(0.8% + 4 digits)
	40.000k $\Omega$	0.001k $\Omega$	
	400.00k $\Omega$	0.01k $\Omega$	
	4.0000M $\Omega$	0.0001M $\Omega$	
	40.000M $\Omega$	0.001M $\Omega$	±(2.5% + 10 digits)
<b>Capacitance</b>	400.00nF	0.01nF	±(5.0% + 40 digits)
	4000.0nF	0.1nF	±(3.0% + 10 digits)
	400.00 $\mu$ F	0.01 $\mu$ F	±(3.5% + 10 digits)
	4000.0 $\mu$ F	0.1 $\mu$ F	±(5.0% + 10 digits)
	40.000mF	0.001mF	
<b>Frequency (clamp)</b>	400.00Hz	0.01Hz	±(1.0% + 3 digits)
	Sensitivity: 5Arms minimum		

Function	Range	Resolution	Accuracy (% of reading + digits)
<b>Frequency</b> (test leads)	40.000Hz	0.001Hz	±(0.3% + 3 digits)
	400.00Hz	0.01Hz	±(0.3% + 2 digits)
	4000.0Hz	0.1Hz	
	40.000kHz	0.001kHz	
	400.00kHz	0.01kHz	
	4000.0kHz	0.1kHz	
	40.000MHz	0.001MHz	
	100.00MHz	0.01MHz	Not specified
	Sensitivity: 5 to 5kHz; 0.8Vrms min., 5kHz to 150kHz; 5Vrms min		
<b>Duty Cycle</b>	0.5% to 99.0%	0.1%	±(1.2% + 2 digits)
	Pulse width: 100µs to 100ms, Frequency: 5Hz to 150kHz		
<b>Temperature</b> <b>Type K</b>	-58 to -4°F -50 to -19°C	0.1° <1000° 1° >1000°	± 7°C/13°F
	-4 to 31°F -20 to -1°C		±(1.0% + 1°C/2°F)
	32°F 0°C		±1°C/2°F
	33 to 211°F 1 to 100°C		±(1.0% + 1°C/2°F)
	212 to 718°F 101 to 399°C		±(1.5% + 2°C/3°F)
	719 to 1832°F 400 to 1000°C		±(2.5% + 4°C/7°F)
	Specification does not include probe accuracy		
<b>Temperature</b> <b>IR</b>	-58 to -4°F -50 to -20°C	0.1°	± 5°C/9°F
	-4 to 31°F -20 to -1°C		±2% of reading or ±2°C/4°F whichever is greater
	32°F 0°C		±1°C/2°F
	33 to 518°F 1 to 270°C		±2% of reading or ±2°C/3°F whichever is greater

## General Specifications

<b>Clamp jaw opening</b>	32mm (1.25") approx.
<b>Display</b>	Dual 40,000/4,000 count backlit LCD
<b>Non-Contact Voltage</b>	100 to 600VAC
<b>Continuity check</b>	Threshold 50Ω; Test current < 0.5mA
<b>Diode test</b>	Test current of 0.3mA typical; Open circuit voltage [ 2.8VDC typical
<b>Low Battery indication</b>	Battery symbol is displayed
<b>Over-range indication</b>	'OL' display
<b>Measurement rate</b>	2 readings per second, nominal
<b>Peak detector</b>	>1ms
<b>Thermocouple sensor</b>	Type K thermocouple required
<b>Fuse</b>	200mA/660V, ceramic, 5x20mm
<b>IR Spectral response</b>	6 to 16μm
<b>IR Emissivity</b>	0.95 fixed
<b>IR distance ratio</b>	8:1
<b>Laser pointer</b>	Class 2 laser < 1mW power; Wavelength is 630 to 670nm
<b>Input Impedance</b>	10MΩ (VDC and VAC)
<b>AC bandwidth</b>	50 to 400Hz (AAC and VAC)
<b>AC response</b>	True rms (AAC and VAC)
<b>Crest Factor</b>	3.0 in 40A and 400A ranges, 1.4 in 1000A range (50/60Hz and 5% to 100% of range)
<b>Operating Temperature</b>	5°C to 40°C (41°F to 104°F)
<b>Storage Temperature</b>	-20°C to 60°C (-4°F to 140°F)
<b>Operating Humidity</b>	Max 80% up to 31°C (87°F) decreasing linearly to 50% at 40°C (104°F)
<b>Storage Humidity</b>	<80%
<b>Operating Altitude</b>	2000meters (7000ft) maximum.
<b>Battery</b>	One (1) 9V Battery (NEDA 1604)
<b>Auto power OFF</b>	After approx. 30 minutes, with disable
<b>Dimensions &amp; Weight</b>	241x96x44.5mm (9.5x3.8x1.75"); 386g (13.6 oz)
<b>Safety</b>	For indoor use and in accordance with the requirements for double insulation to IEC1010-1 (2001); EN61010-1 (2001) Overvoltage Category III 600V and Category II 1000V, Pollution Degree 2.
<b>Approvals</b>	CE
<b>Patent notice</b>	U.S. Patent 7163336

**Copyright © 2012 Extech Instruments Corporation (a FLIR company)**

All rights reserved including the right of reproduction in whole or in part in any form.  
[www.extech.com](http://www.extech.com)