

User's Guide

EXTECH[®]
INSTRUMENTS

A FLIR COMPANY

800 Amp True RMS AC Clamp Meter Model EX720

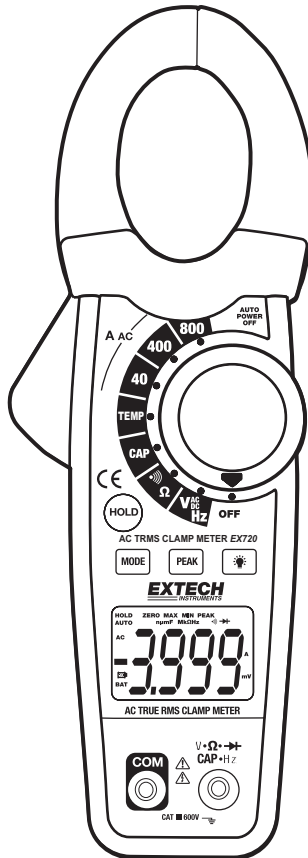

Introduction

Congratulations on your purchase of the EX720 Clamp DMM. Careful use of this meter will provide many years of reliable service.

Safety

International Safety Symbols



This symbol, adjacent to another symbol or terminal, indicates the user must refer to the manual for further information.



This symbol, adjacent to a terminal, indicates that, under normal use, hazardous voltages may be present



Double insulation

SAFETY NOTES

- Do not exceed the maximum allowable input range of any function.
- Do not apply voltage to meter when resistance function is selected.
- Set the function switch OFF when the meter is not in use.
- Remove the battery if meter is to be stored for longer than 60 days.

WARNINGS

- Set function switch to the appropriate position before measuring.
- When measuring volts do not switch to current/resistance modes.
- Do not measure current on a circuit whose voltage exceeds 600V.
- When changing ranges always disconnect the test leads from the circuit under test.

UL Note

A UL mark does not indicate that this product has been evaluated for accuracy.



| Function | Maximum Input |
|------------------------------------------------|----------------|
| A AC | 800A AC |
| V DC, V AC | 600V DC/AC |
| Resistance, Capacitance, Frequency, Diode Test | 250V DC/AC |
| Temperature | 60V DC, 24V AC |

CAUTIONS

- Improper use of this meter can cause damage, shock, injury or death. Read and understand this user manual before operating the meter.
- Always remove the test leads before replacing the battery or fuses.
- Inspect the condition of the test leads and the meter itself for any damage before operating the meter. Repair or replace any damage before use.
- Use great care when making measurements if the voltages are greater than 25VAC rms or 35VDC. These voltages are considered a shock hazard.
- Always discharge capacitors and remove power from the device under test before performing Diode, Resistance or Continuity tests.
- Voltage checks on electrical outlets can be difficult and misleading because of the uncertainty of connection to the recessed electrical contacts. Other means should be used to ensure that the terminals are not "live".
- If the equipment is used in a manner not specified by the manufacturer, the protection provided by the equipment may be impaired.
- This device is not a toy and must not reach children's hands. It contains hazardous objects as well as small parts that the children could swallow. In case a child swallows any of them, please contact a physician immediately
- Do not leave batteries and packing material lying around unattended; they can be dangerous for children if they use them as toys
- In case the device is going to be unused for an extended period of time, remove the batteries to prevent them from training
- Expired or damaged batteries can cause cauterization on contact with the skin. Always, therefore, use suitable hand gloves in such cases
- See that the batteries are not short-circuited. Do not throw batteries into the fire.

Description

Meter Description

1. Current clamp
2. Clamp opening trigger
3. Control buttons:
 - Data Hold
 - Mode
 - Peak
 - Backlight 
4. Backlit LCD Display
5. **COM** negative input jack for black test lead
6. Rotary function switch
7. **V · Ω · CAP · TEMP · Hz · ** positive input jack for red lead

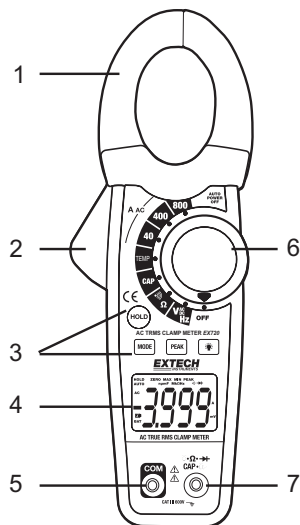

Display icons Description

| | |
|------------------------------------------------------------------------------------|--------------------------------------------------------------|
| HOLD | Data Hold |
| Minus sign | Negative reading display |
| 0 to 3999 | Measurement display digits |
| PEAK | Peak capture |
| AUTO | Auto Range mode |
| DC/AC | Direct Current / Alternating Current |
| BAT | Low battery |
| mV or V | Milli-volts or Volts (Voltage) |
| Ω | Ohms (Resistance) |
| A | Amperes (Current) |
| F | Farad (Capacitance) |
| Hz | Hertz (Frequency) |
| °F and °C | Fahrenheit and Celsius units (Temperature) |
| n, m, μ, M, k | Unit of measure prefixes: nano, milli, micro, mega, and kilo |
| •))) | Continuity test |
|  | Diode test |

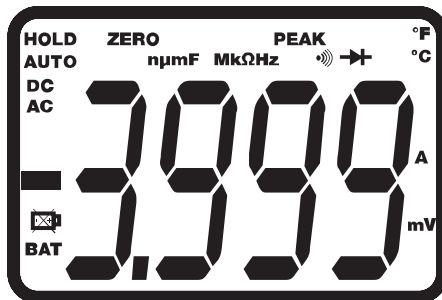

Operation

NOTES: Read and understand all **Warning** and **Caution** statements in this operation manual prior to using this meter. Set the function select switch to the OFF position when the meter is not in use.

AC Current Measurements

WARNING: Ensure that the test leads are disconnected from the meter before making current clamp measurements.

1. Set the Function switch to the **800A, 400A, or 40A** range. If the approx. range of the measurement is not known, select the highest range then move to the lower ranges if necessary.
2. Press the trigger to open jaw. Fully enclose only one conductor. For optimum results, center the conductor in the jaw.
3. The clamp meter LCD will display the reading.

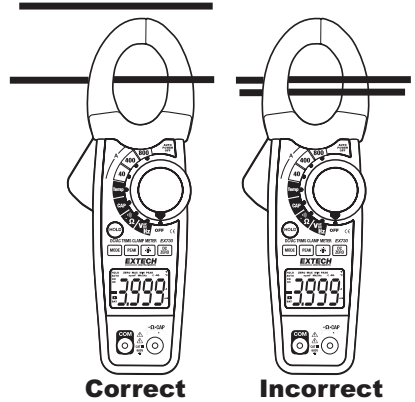

AC/DC Voltage Measurements

1. Insert the black test lead into the negative **COM** terminal and the red test lead into the positive **V · Ω · CAP TEMP · Hz ·** terminal.
2. Set the function switch to the **V Hz** position.
3. Use the **MODE** button to select AC or DC Voltage.
4. Connect the test leads in parallel to the circuit under test.
5. Read the voltage measurement on the LCD display.

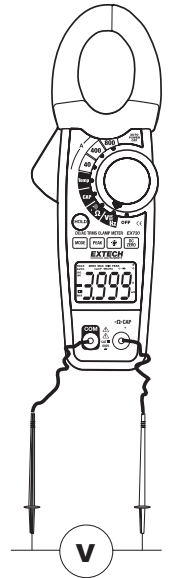

Resistance Measurements

1. Insert the black test lead into the negative **COM** terminal and the red test lead into the **V·Ω·CAP·TEMP Hz** positive terminal.
2. Set the function switch to the **Ω** position.
3. Touch the test probe tips across the circuit or component under test.
4. Read the resistance on the LCD display.



Capacitance Measurements

WARNING: To avoid electric shock, discharge the capacitor under test before measuring.

1. Set the function switch to the **CAP** position.
2. Insert the black test lead banana plug into the negative **COM** jack and the red test lead banana plug into the **V·Ω·CAP·TEMP Hz** positive jack.
3. Touch the test probe tips across the part under test. If "dISC" appears in the display, remove and discharge the component.
4. Read the capacitance value in the display.
5. The display will indicate the proper decimal point and value.

Note: For very large values of capacitance measurement it can take several minutes before the final reading stabilizes.



Frequency Measurements

1. Insert the black test lead banana plug into the negative **COM** jack and the red test lead banana plug into the **V·Ω·CAP·TEMP Hz** positive jack.
2. Set the function switch to the **V Hz** Position.
3. Press and hold the **MODE** button to select the Frequency (Hz) function. "k Hz" will appear in the display.
4. Touch the test probe tips across the part under test.
5. Read the Frequency value on the display.
6. The display will indicate the proper decimal point and value.
7. Press and hold the **MODE** button again to return to the voltage mode.



Temperature Measurements

1. Set the function switch to the **TEMP** position.
2. Insert the Temperature Probe into the negative **COM** and the **V·Ω·CAP·TEMP·Hz·** \rightarrow positive jacks, observing polarity.
3. Touch the Temperature Probe head to the device under test. Continue to touch the part under test with the probe until the reading stabilizes.
4. Read the temperature on the display. The digital reading will indicate the proper decimal point and value.
5. Use the **MODE** button to select °F or °C.

WARNING: To avoid electric shock, be sure the thermocouple probe has been removed before changing to another measurement function.



Continuity Measurements

1. Insert the black test lead into the negative **COM** terminal and the red test lead into the **V·Ω·CAP·TEMP Hz·** \rightarrow positive terminal.
2. Set the function switch to the **•••••** position.
3. Use the **MODE** button to select continuity "**•••••**". The display icons will change when the **MODE** button is pressed.
4. Touch the test probe tips across the circuit or component under test.
5. If the resistance is $< 40\Omega$, a tone will sound.

Diode Test

1. Insert the black test lead banana plug into the negative COM jack and the red test lead banana plug into the **V·Ω·CAP·TEMP Hz·** \rightarrow positive jack
2. Turn the function switch to \rightarrow position. Use the MODE button to select the diode function if necessary (diode symbol will appear on the LCD when in Diode test mode)
3. Touch the test probe tips to the diode or semiconductor junction under test. Note the meter reading
4. Reverse the test lead polarity by reversing the red and black leads. Note this reading
5. The diode or junction can be evaluated as follows:
 - If one reading displays a value (typically 0.400V to 0.900V) and the other reading displays **OL**, the diode is good.
 - If both readings display **OL** the device is open.
 - If both readings are very small or '0', the device is shorted.

Data Hold

To freeze the LCD reading, press the **HOLD** button. While data hold is active, the **HOLD** icon appears on the LCD. Press the **HOLD** button again to return to normal operation.

Peak Hold

The Peak Hold function captures the peak AC or DC voltage or current. The meter can capture negative or positive peaks as fast as 1 millisecond in duration.

1. Turn the function switch to the A or V position.
2. Allow time for the display to stabilize.
3. Press and Hold the **PEAK** button until "**CAL**" appears in the display. This procedure will zero the range selected.
4. Press the **PEAK** button, **Pmax** will display.
5. The display will update each time a higher positive peak occurs.
6. Press the **PEAK** button again, **Pmin** will display. The display will now update and indicate the lowest negative peak.
7. To return to normal operation, press and hold the **PEAK** button until the **Pmin** or **Pmax** indicator switches off.

Note: If the Function switch position is changed after a calibration the Peak Hold calibration must be repeated for the new function selected.

LCD Backlight Button

The LCD is equipped with backlighting. Press the backlight button to turn the backlight on. Press again to turn the backlight off.

Automatic Power OFF

In order to conserve battery life, the meter will automatically turn off after approximately 25 minutes. To turn the meter on again, turn the function switch to the OFF position and then to the desired function position.

Specifications

| Function | Range & Resolution | Accuracy (% of reading + digits) | |
|-------------------------------------------|------------------------------------------------------------------|----------------------------------|---------------------|
| AC Current 50/60 Hz True RMS | 40.00A AC | $\pm (2.5\% + 10d)$ | |
| | 400.0A AC | $\pm (2.5\% + 8d)$ | |
| | 800A AC | $\pm (2.8\% + 5d)$ | |
| AC Voltage 50/60Hz True RMS | 400.0mV AC | $\pm (1.0\% + 10d)$ | |
| | 4.000V AC | $\pm (1.5\% + 5d)$ | |
| | 40.00V AC | | |
| | 400.0V AC | | |
| | 600V AC | $\pm (2.0\% + 5d)$ | |
| DC Voltage | 400.0mV DC | $\pm (0.8\% + 2d)$ | |
| | 4.000V DC | $\pm (1.5\% + 2d)$ | |
| | 40.00V DC | | |
| | 400.0V DC | | |
| | | 600V DC | $\pm (2.0\% + 2d)$ |
| Resistance | 400.0 Ω | $\pm (1.0\% + 4d)$ | |
| | 4.000k Ω | $\pm (1.5\% + 2d)$ | |
| | 40.00k Ω | | |
| | 400.0k Ω | | |
| | | 4.000M Ω | $\pm (2.5\% + 3d)$ |
| | | 40.00M Ω | $\pm (3.5\% + 5d)$ |
| Capacitance | 4.000nF | $\pm (5.0\% + 30d)$ | |
| | 40.00nF | $\pm (5.0\% + 20d)$ | |
| | 400.0nF | $\pm (3.0\% + 5d)$ | |
| | 4.000 μ F | | |
| | 40.00 μ F | | |
| | | 400.0 μ F | $\pm (4.0\% + 10d)$ |
| | | 4.000mF | $\pm (10\% + 10d)$ |
| | | 40.00mF | unspecified |
| Frequency | 4.000kHz | $\pm (1.5\% + 2d)$ | |
| | Sensitivity: 100V (<50Hz); 50V (50 to 400Hz); 5V (401 to 4000Hz) | | |
| Temperature | -4 to 1400°F | $\pm (3\%rdg + 9^\circ F)$ | |
| | -20 to 760°C | $\pm (3\%rdg + 5^\circ C)$ | |

General Specifications

| | |
|--------------------------------|---------------------------------------------------------------------------------------------------------------------------------------------------------------------------------------------|
| Clamp jaw opening | 30mm (1.2") approx. |
| Display | 3-3/4 digits (4000 counts) backlit LCD |
| Continuity check | Threshold 40Ω; Test current < 0.5mA |
| Diode test | Test current of 0.3mA typical; Open circuit voltage < 3VDC typical |
| Low Battery indication | 'BAT' is displayed |
| Over-range indication | 'OL' display |
| Measurement rate | 2 readings per second, nominal |
| PEAK | Captures peaks >1ms |
| Temperature sensor | Type K thermocouple |
| Input Impedance | 10MΩ (VDC and VAC) |
| AC bandwidth | 50 to 400Hz (AAC and VAC) |
| AC response | True rms (AAC and VAC) |
| Crest Factor | 3.0 in 40A and 400A ranges, 1.4 in 800A range (50/60Hz and 5% to 100% of range) |
| Operating Temperature | 5°C to 40°C (41°F to 104°F) |
| Storage Temperature | -20°C to 60°C (-4°F to 140°F) |
| Operating Humidity | Max 80% up to 31°C (87°F) decreasing linearly to 50% at 40°C (104°F) |
| Storage Humidity | <80% |
| Operating Altitude | 2000meters (7000ft). maximum. |
| Battery | One (1) 9V Battery |
| Auto power OFF | After approx. 25 minutes |
| Dimensions & Weight | 229 x 80 x 49mm (9.0 x 3.1 x 2.0"); 303g (10.7 oz). |
| Safety | For indoor use and in accordance with the requirements for double insulation to IEC1010-1 (2001): EN61010-1 (2001) Overvoltage Category III 600V and Category II 1000V, Pollution Degree 2. |

Maintenance

WARNING: To avoid electrical shock, disconnect the meter from any circuit, remove the test leads from the input terminals, and turn OFF the meter before opening the case. Do not operate the meter with an open case.

Cleaning and Storage

Periodically wipe the case with a damp cloth and mild detergent; do not use abrasives or solvents. If the meter is not to be used for 60 days or more, remove the battery and store it separately.

Battery Replacement

1. Remove the Phillips head screw that secures the rear battery door
2. Open the battery compartment
3. Replace the 9V battery
4. Secure the battery compartment



You, as the end user, are legally bound (**EU Battery ordinance**) to return all used batteries, **disposal in the household garbage is prohibited!** You can hand over your used batteries / accumulators at collection points in your community or wherever batteries / accumulators are sold!

Disposal: Follow the valid legal stipulations in respect of the disposal of the device at the end of its lifecycle

Copyright © 2012 Extech Instruments Corporation (a FLIR company)

All rights reserved including the right of reproduction in whole or in part in any form.
www.extech.com