

User's Guide

**EXTECH**<sup>®</sup>  
**INSTRUMENTS**

A FLIR COMPANY

## Multifunction Voltage Tester

Model VT10

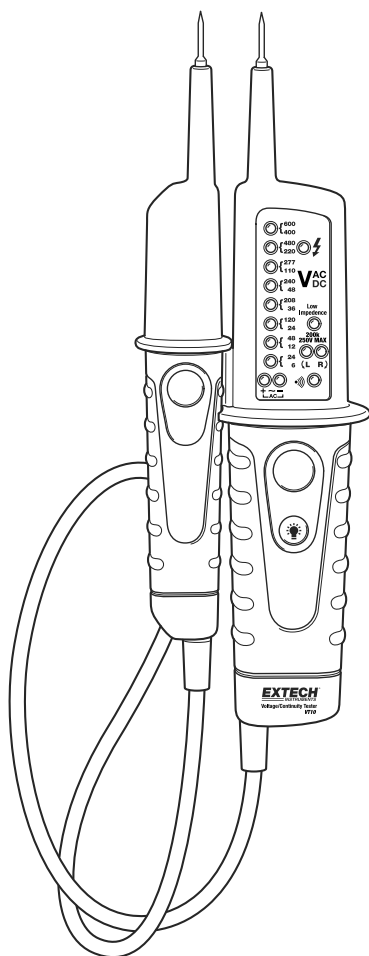

## Introduction

---

Congratulations on your purchase of the Extech VT10 Multifunction Voltage Tester. The VT10 measures AC Voltage to 600V and DC Voltage to 400V with LED indicators, and LEDs for positive and negative polarity. Additional features include audible continuity beeper, low impedance mode for eliminating phantom voltages, and a built-in flashlight to illuminate test connections during measurements. This meter is shipped fully tested and with proper use will provide years of reliable service.

## Safety

---

### International Safety Symbols



This symbol, adjacent to another symbol or terminal, indicates the user must refer to the manual for further information.



This symbol, adjacent to a terminal, indicates that, under normal use, hazardous voltages may be present



Double insulation

### Safety Precautions

1. Improper use of this meter can cause damage, shock, injury or death. Read and understand this manual before use.
2. Ensure that any covers or battery doors are properly closed and secured before use.
3. Inspect the condition of the test leads and the meter itself for any damage before use.
4. Do not exceed the rated input limits.
5. Use great care when taking measurements greater than 25VAC rms or 35VDC. These voltages are considered a shock hazard.
6. Discharge capacitors and remove power from the DUT before Continuity tests.
7. Remove the batteries from the meter if the meter is to be stored for long periods.
8. Voltage measurement results on electrical outlets can be misleading because of the difficulty in making a proper connection to the electrical contacts.
9. **NEVER** apply voltage to the meter that exceeds the specified maximum:

Input Protection Limits	
Function	Maximum Input
VAC, VDC, Continuity	600VAC: 30 second max 400VDC: 30 second max

10. **USE EXTREME CAUTION** when working with high voltages.
11. **ALWAYS** discharge filter capacitors in power supplies and disconnect the power when making continuity tests.
12. **ALWAYS** disconnect the test leads before opening the cover to replace the battery.
13. **NEVER** operate the meter unless the battery cover is in place and fastened securely.

## Description

---

1. Test Probe (-)
2. Test Probe (+)
3. Flashlight
4. LED voltage level indicators
5. LED (AC voltage indicator)
6. LED (low impedance test indicator)
7. LED (phase sequence direction indicators)
8. LED (continuity indicator)
9. LED (AC/DC +V/-V polarity voltage indicators)
10. Low impedance button (+)
11. Flashlight button
12. Battery cover
13. Low impedance button (-)

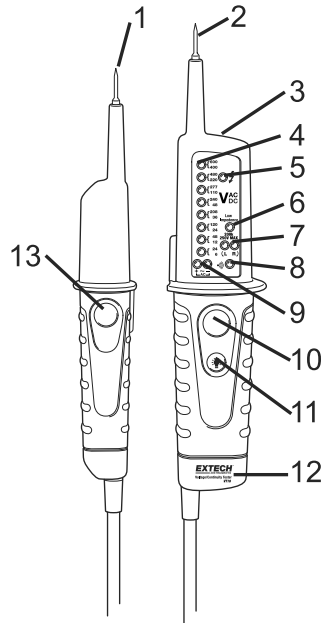

## Operation



**Always test the meter on a known live circuit before taking measurements**

### Voltage Measurement

1. Note: The voltage tester will turn on automatically when voltages higher than 4.5V AC/DC are detected.
2. Touch the positive (+) and negative (-) test leads to the device or circuit under test.
3. If the voltage is higher than 4.5V AC/DC, the voltage level LEDs will light and display the reading.
4. For AC voltages, the ⚡ LED and the "AC" LEDs will light in the display. For DC voltages, the "+V" or "-V" LED will light to indicate polarity. In addition, when negative DC voltages are measured, the continuity LED will light and the audible alert will sound.

Note: The measurement time should not exceed 30 seconds. After 30 seconds the meter should be allowed to cool for 10 minutes.

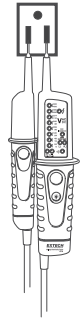

### Single Lead AC Voltage Detection

To check for the presence of voltage (between 100V and 600V) using only the positive test lead (+), touch the lead to the device or circuit under test. If voltage is present, the ⚡ LED will light and the audible alert will sound.

**Note:** In this mode, the actual voltage is not displayed; only the presence of voltage is detected.

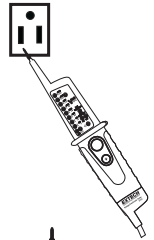

### Low Impedance Voltage Measurement

Due to the lowered internal impedance, capacitive voltage is suppressed so that the reading shows the actual voltage applied. This can be used to quickly identify phantom voltages.

1. Hold the two test tips on the measuring points to be tested.
2. Press the two low impedance test buttons simultaneously.
3. The Low Impedance LED will light and the applied voltage will be displayed on the LEDs.

**Note:** The maximum duty cycle in this mode is 5 seconds for voltages up to 250V. Allow 10 minutes between each reading.

**Note:** Measuring from hot to ground may trip any GFCI equipped circuits.

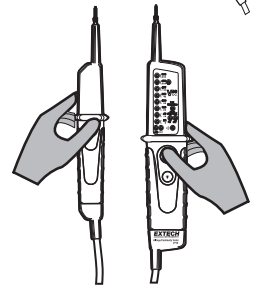

### Continuity Test

The tester can measure resistance and alert the user if the resistance value is less than 400kΩ.

1. Before taking a continuity test, make sure that power to the device or circuit under test is off and that all capacitors are discharged.
2. Touch the test tips to the device under test.
3. If the resistance is less than 400kΩ., the tester will sound an audible alert and the  continuity LED will light.

## Flashlight

Press and hold the  button to turn the flashlight on. Release the button to turn the flashlight off.

## 3-Phase Rotation

The 3-phase rotation function indicates whether the 3 phase AC lines or mains are live and also identifies the phase orientation of the three wires before attaching them to a motor or other equipment. The phase sequence will determine the direction (Clockwise or Counter-clockwise) a motor will rotate when connected.

To determine clockwise rotation (P1-P2-P3)

1. Touch probe L1 to any one of the three AC mains. Label this phase P1.
2. Touch probe L2 to the other two phases. One phase will indicate “L” and one will indicate “R”
3. Label the phase that indicates “R” as P2.
4. Touch probe L1 to phase P2 and touch probe L2 to the remaining unlabeled AC main wire. The “R” icon will illuminate. Label this phase P3.
5. The clockwise sequence P1-P2-P3 (also known as 1-2-3 or R-S-T) has been identified.
6. To determine a counterclockwise rotation exchange the “L” and “R” in the procedure.

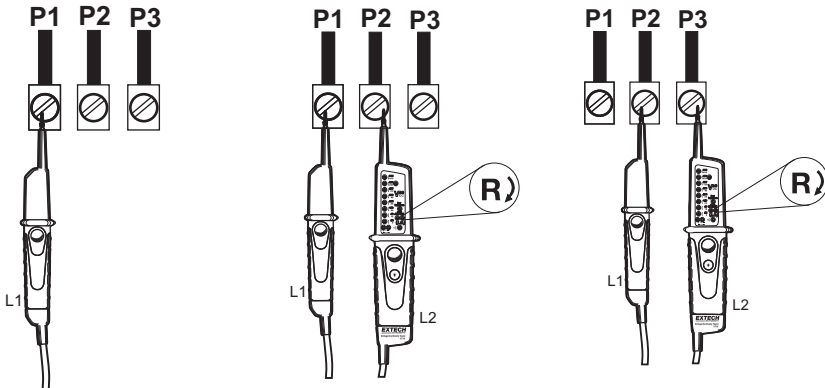

## Maintenance

---

### Battery replacement

1. Disconnect the meter from any test device or circuit before opening the tester.
2. Loosen the recessed Phillips head screw at the bottom of the tester. Do not remove the screw.
3. Hold the meter and pull the lower portion of the meter off until the batteries are exposed.
4. Replace the two 'AAA' batteries observing polarity and dispose of the old batteries properly.
5. Slide the meter back together and replace the screw.

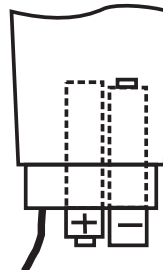

### Cleaning and Storage

Before cleaning the tester, ensure that the test leads are not connected to any circuit or device. Wipe the meter only with a damp cloth as needed. Do not apply abrasives, solvents, or other cleaners to the surface of the meter. Store with the battery removed and avoid extreme temperature and humidity.

## Specifications

---

Voltage LED steps	AC: 24, 48, 120, 208, 240, 277, 480, 600 DC: 6, 12, 24, 36, 48, 110, 220, 400
ACV frequency range	50/60Hz
LED enable input voltage	>4.5V AC/DC
Accuracy	-30% to 0% of the indication
Range selection	Automatic
Max measuring current	≤1.2mA (600VAC); ≤1.0mA (400VDC)
Display delay	LED indication <0.1s
Input Impedance	1MΩ (approx)
Continuity test	Range 0 to 400kΩ, guaranteed on < 50kΩ; <10μA test current;
Low impedance test	12-250VAC/DC; impedance <6kΩ;
Operation time:	30 seconds on/10 minute off duty cycle
Power supply	2 x "AAA" 1.5V alkaline batteries, 50mA max
Battery life	Approx. 8 hours continuous use typical
Operating Temperature	14 to 131°F (-10 to 55°C)
Storage Temperature	-22 to 140°F (-30 to 60°C)
Operating Humidity	10 to 85% RH (non-condensing)
Operating Altitude	7000 ft. (2000 meters) maximum
Safety	This meter is intended for origin of installation use and protected, against the users, by double insulation per EN61243-3:2010 CATIII 600V and CAT IV 600V.
Approvals	CE, IP64
Dimensions	9.4 x 3 x 1.6" (240 x 78 x 40mm)
Weight	9.2oz (260g)

## **Warranty**

---

**EXTECH INSTRUMENTS CORPORATION** (a FLIR company) warrants this instrument to be free of defects in parts and workmanship for **one year** from date of shipment (a six month limited warranty applies to sensors and cables). If it should become necessary to return the instrument for service during or beyond the warranty period, contact the Customer Service Department for authorization. Visit our website [www.extech.com](http://www.extech.com) for contact information. A Return Authorization (RA) number must be issued before any product is returned to Extech. The sender is responsible for shipping charges, freight, insurance and proper packaging to prevent damage in transit. This warranty does not apply to defects resulting from action of the user such as misuse, improper wiring, operation outside of specification, improper maintenance or repair, or unauthorized modification. Extech specifically disclaims any implied warranties or merchantability or fitness for a specific purpose and will not be liable for any direct, indirect, incidental or consequential damages. Extech's total liability is limited to repair or replacement of the product. The warranty set forth above is inclusive and no other warranty, whether written or oral, is expressed or implied.

### **Calibration and Repair Services**

**Extech offers repair and calibration services** for the products we sell. Extech also provides NIST certification for most products. Call the Customer Service Department for information on calibration services available for this product. Extech recommends that annual calibrations be performed to verify meter performance and accuracy.

**Support lines: U.S. 877-439-8324, Intl. 603-324-7800**

Technical support: Option 3; E-mail: [support@extech.com](mailto:support@extech.com)

Repair & Returns: Option 4; E-mail: [repair@extech.com](mailto:repair@extech.com)

**Product specifications subject to change without notice**

Visit our website: [www.extech.com](http://www.extech.com)

Extech Instruments Corporation, 9 Townsend West, Nashua, NH 03063

*ISO 9001 Certified since 1995*